

Item	Name	Q.ty
1	01.01.017	1

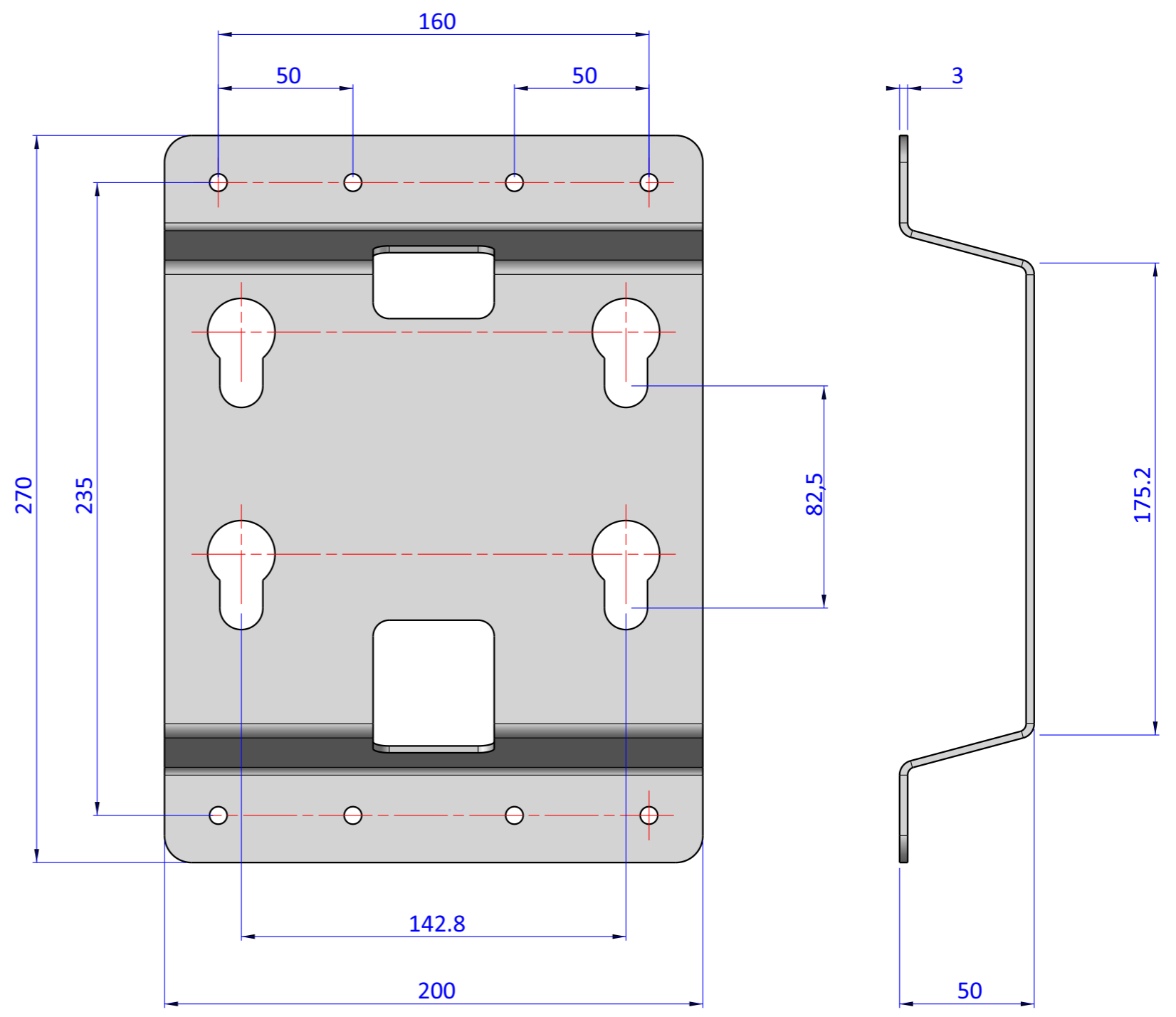
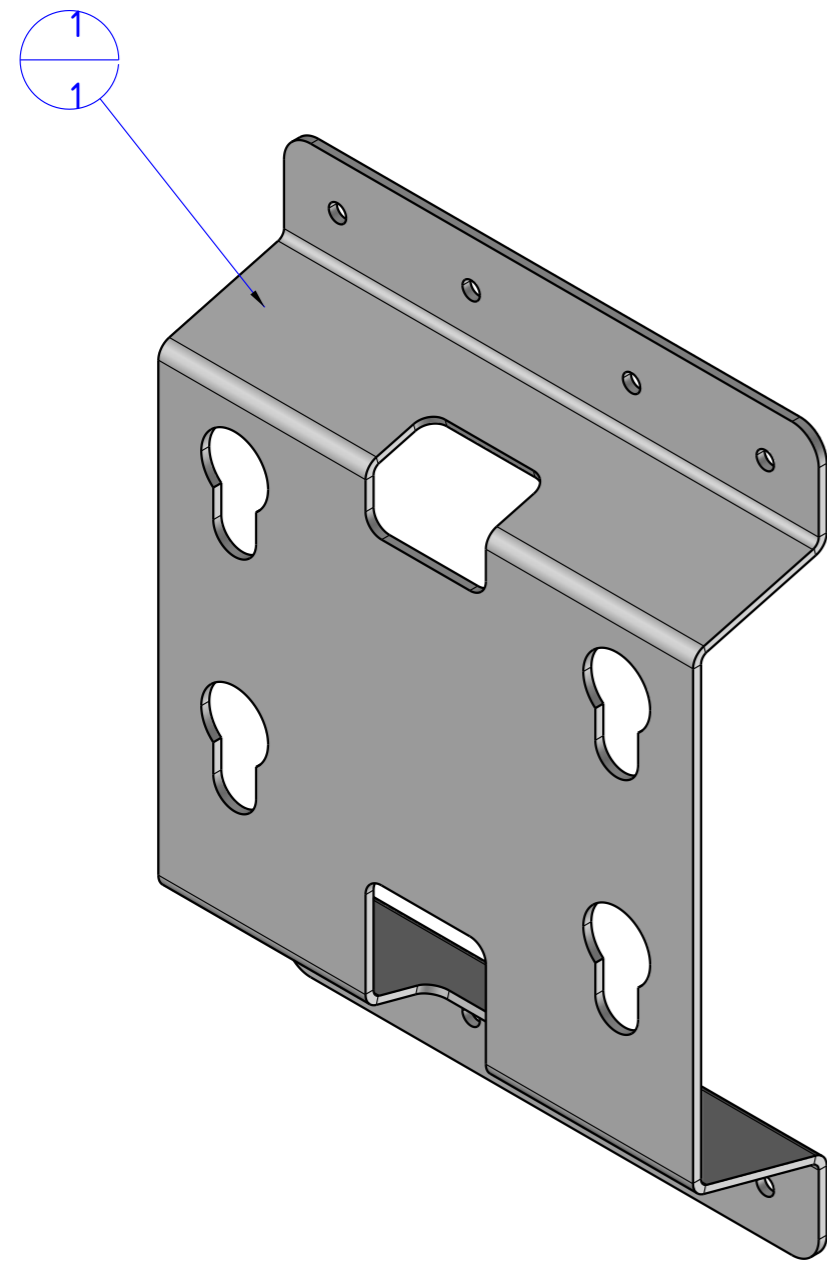

THE PROPERTY OF THE DRAWING IS ESTABLISHED BY LAW. IT IS FORBIDDEN TO PRODUCE OR SHOW IT TO THIRD PART. WITHOUT A WRITTEN AGREEMENT.

Format A3
UNI 936-76

FPS FPSERVICES AUTOMATION			DESIGNED FROM FPS Automation	REVIEW A
GENERAL TOLERANCE UNI - ISO 2768 CLASSE f	DESCRIPTION CA.01.01.017		DATE 07/04/2021	WEIGHT 1,374kg
			CODE CA.01.01.017	